



Wall Mounting Cabinets



Networking Enclosures / Cabinets, designed for customer friendly product assembly and superior Logistics advantages in terms of shipping costs. Superior load performance tested with 25% more than nominal load capacity, nominal weight load is 80 kg, tested up to 100 kg ideal for carrying heavy telecom equipment, UPS and batteries rather than just standard network technology equipment such as switches, patch panels and cables.

High technology fully automated production offers the 600x450 mm, 600x600 mm WB PROlineB New Series, which are available in 6 heights from 4U to 18U. Each cabinet is supplied as standard with a safety glass front door, removable side panels with 2 pcs Slam Latches. Side panels are also fitted with a dummy plastic cover on the barrel locking location in centre. Optional accessory kit set of 2 pcs barrel (O shape/ Quarter Turn keyed Cam Lock) can be installed to provide more security.

Compliance with standards:

- With the EN 12150-1 standard antistatic, transparent safety glass 4,0 mm front glass door.
- Round quarter turn lock which is compatible with DIN 1743, DIN 53571, RoHS.
- EN 60297- Mechanical constructions for electronic devices. mechanical constructions (19 inch series) with standard universal 482,6 mm profiles
- EN 60917- Modular layout for development of mechanical constructions in electronic equipment applications.

- EN 61587-1 For electronic devices inner usage mechanic construction cabinets, bottom shelves, cases, IEC 60917 and IEC 60297 series tests, Chapter 1, environmental conditions, test setup and security rules.
- EIA/ ECA-310 (D/E) 19" 482,6 mm and U 44,45 mm Height Sizing
- Climatic and environment: EN 61587-1/4.2, IEC 60068-2-1, IEC 60068-2-2, IEC 60068-2-30
- Static Mechanical Load Lifting: EN 61587-1/5.2.1
- Static Mechanical Load Stiffness: EN 61587-1/5.2.2
- Dynamic mechanical load vibration and shock, impact: EN 61587-1/5.3.1, EN 61587-1/5.3.3, IEC 60068-2-6, IEC 60068-2-27 • Grounding: EN 61587-1/6.2
- Fireproofing: EN 61587-1/6.3 • IP protection class (IP code): IP20, EN 61587-1/6.4
- The powder paint used is non-flammable and has a flame-retardant resistant according to TS EN 13501-1 + A1 standard
- TS EN ISO 9227 corrosion tests, salt spraying tests, TS EN ISO 2409 paints and varnishes, cross cutting test, TS 2311 EN ISO2178 above magnetic metals non-magnetic covering, measuring covering thickness, magnetic method
- 2011/65/EU- regulation of hazardous material restriction/ RoHS suitability
- TS EN 60950-1 information technology devices, Security- Chapter 1
- General rules- CE conformity • Sheet steel: DIN 934, DIN 985, DIN 933 - EN ISO 2081 metallic and other inorganic coverings covered above iron or steel with the additional process electrolytic zinc covering standards

Technical Drawings

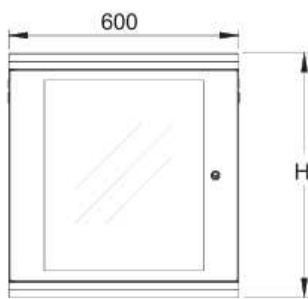

Front view

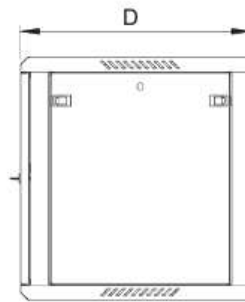

Side view

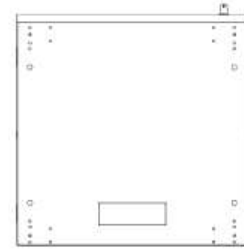

Bottom view

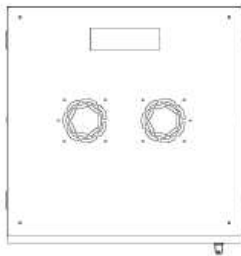

Top view

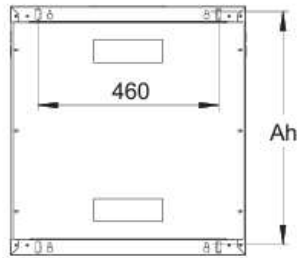

Rear view

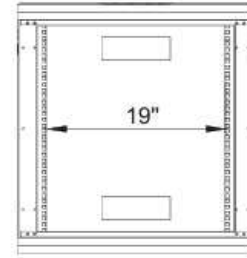

Front inside view



Isometric view

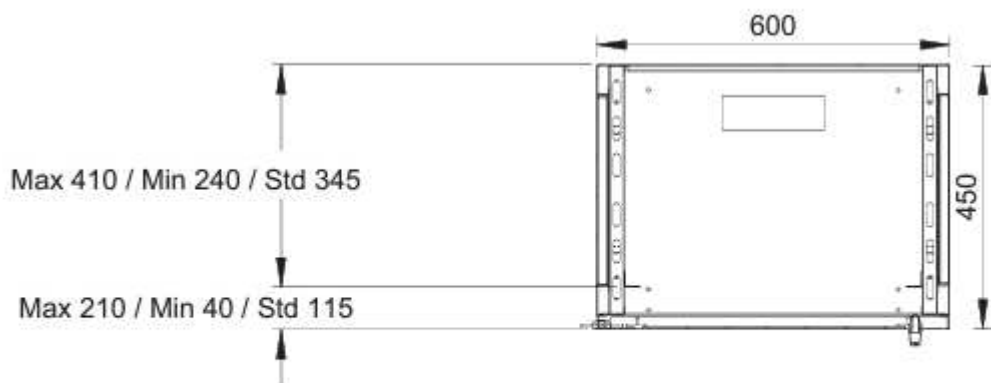
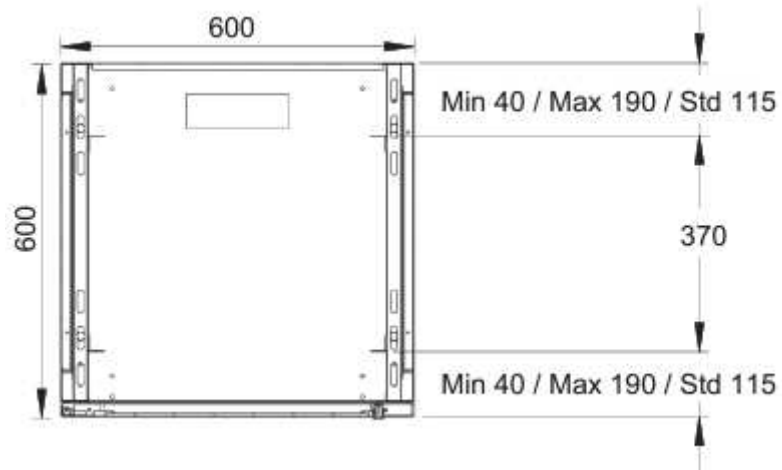

Max / Min / Std
Equipment Mounting Distance

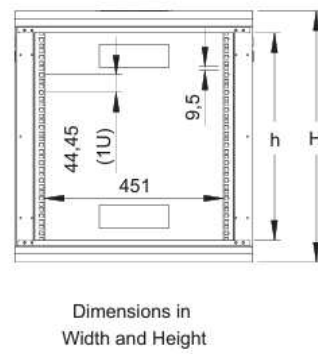
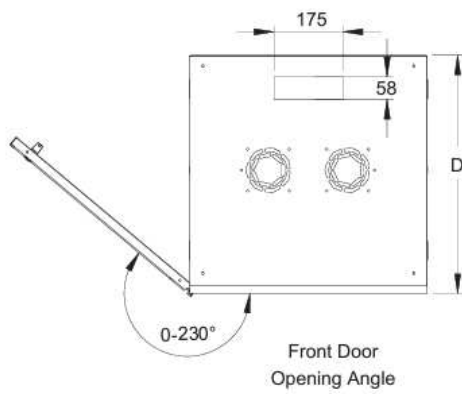

U Height	Size D	h	H	Ah
4U	450/600	178	290	251
6U	450/600	267	379	340
9U	450/600	400	512	473
12U	450/600	533	645	606
15U	450/600	667	779	740
18U	450/600	800	912	873